

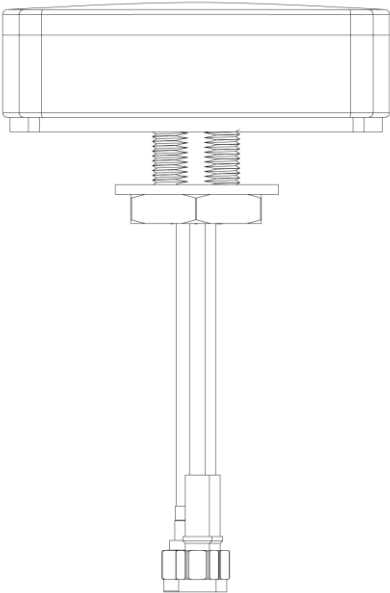

AREA OF REFUGE USER MANUAL AND INSTALLATION GUIDE

Read and save these instructions before installation and use



Model number(s)
HON-AOR-CGW-ANT-6-KIT
HON-AOR-CGW-ANT-17-KIT

DISCLAIMER

This document contains Talkaphone proprietary information.

Information contained herein is to be used solely for the purpose submitted, and no part of this document or its contents shall be reproduced, published, or disclosed to a third party without the express permission of Talk-A-Phone, LLC.

While this information is presented in good faith and believed to be accurate, Talkaphone disclaims the implied warranties of merchantability and fitness for a purpose and makes no express warranties except as may be stated in its written agreement with and for its customer.

In no event is Talkaphone liable to anyone for any direct, special, or consequential damages. The information and specifications in this document are subject to change without notice.

Talk-A-Phone and Talkaphone are registered trademarks of Talk-A-Phone, LLC. All rights reserved. Find out more at www.talkaphone.com.

The Honeywell trademark is used under license from Honeywell International Inc.

Honeywell International Inc. makes no representation or warranties with respect to these products. These products are manufactured by Talk-A-Phone, LLC, Niles, IL 60714, USA.

Copyright 2024 Talk-A-Phone, LLC

 CAUTION	<p>THIS PRODUCT MUST BE INSTALLED IN ACCORDANCE WITH THE NFPA 72 STANDARD, THE NATIONAL ELECTRIC CODE (NEC), AND ALL APPLICABLE FEDERAL, STATE, AND LOCAL STATUTES, REGULATIONS, AND BUILDING CODES.</p> <p>THIS PRODUCT MUST BE INSTALLED IN ACCORDANCE WITH THE APPLICABLE INSTALLATION CODE BY A PERSON FAMILIAR WITH THE CONSTRUCTION AND OPERATION OF THE PRODUCT AND THE HAZARDS INVOLVED.</p>
--	--

Table of contents

ABOUT THIS GUIDE.....	4
CONTENTS	5
TECHNICAL REQUIREMENTS	6
INSTALLATION	7
SERVICING	10
LIMITED WARRANTY INFORMATION.....	11

About this guide

Scope

This installation guide describes how to install and maintain Model **HON-AOR-CGW-ANT-6-KIT** or Model **HON-AOR-CGW-ANT-17-KIT**.

It is recommended that this instruction set be read completely prior to the start of any installation.

Revision history

Revision	Supported Release	Date	Description
1.0		July 15, 2024	<ul style="list-style-type: none">Initial release of HON-AOR-CGW-ANT-6-KIT and HON-AOR-CGW-ANT-17-KIT.

Intended audience

This guide is primarily intended for field personnel who install and configure the product.

Related documents

The following list identifies publications that may contain information relevant to the information in this document:

- None at this time

Contents

Please ensure receipt of each of the included **HON-AOR-CGW-ANT External Antenna** components:

Qty	Part Number	Description
1	160-00085,	3-in-1 external 4G/LTE antenna with screw mount and 6-foot cable assembly (2x LTE (SMA M) and 1X GPS (SMA M))
	Or 160-00086	3-in-1 external 4G/LTE antenna with screw mount and 17-foot cable assembly (2x LTE (SMA M) and 1X GPS (SMA M))
1	810-00033	Pole-mount bracket with U-bolt

 ATTENTION	You should inspect the HON-AOR-CGW-ANT External Antenna when unpacking the box for possible damage in shipment. If it is damaged or any of the components are missing, please contact your distributor immediately. Do not discard any hardware or packing material before you are certain you have all the items listed above, and the unit is installed and functioning correctly.
--	--

 CAUTION	THIS PRODUCT MUST BE INSTALLED IN ACCORDANCE WITH THE NFPA 72 STANDARD, THE NATIONAL ELECTRIC CODE (NEC), AND ALL APPLICABLE FEDERAL, STATE, AND LOCAL STATUTES, REGULATIONS, AND BUILDING CODES.
--	--

Technical Requirements

The **HON-AOR-CGW-ANT External Antenna** is a required component for the following HON-AOR-CGW-4G Cellular Gateway models:

- **HON-AOR-CGW-4G-GSM**
- **HON-AOR-CGW-4G-V**

 CAUTION	THIS PRODUCT MUST BE INSTALLED IN ACCORDANCE WITH THE NFPA 72 STANDARD, THE NATIONAL ELECTRIC CODE (NEC), AND ALL APPLICABLE FEDERAL, STATE, AND LOCAL STATUTES, REGULATIONS, AND BUILDING CODES.
--	--

Installation

 CAUTION	<p>It is the installer’s obligation to ensure compliance with all national, regional, and local regulations. Installation should be performed only by qualified personnel in accordance with the National Electrical Code (NEC), NFPA 72, and other federal, state, and local statutes and building codes. Using shielded cable is recommended to avoid noise, hum, and other operational anomalies.</p>
--	--

 CAUTION	<p>DE-ENERGIZE POWER SUPPLY PRIOR TO SERVICING.</p> <p>For continued protection against risk of electric shock and fire hazard replace fuse with the same type and rating. Do not expose to rain or moisture.</p>
--	--

Connections

The following table provides further details on the labeling of the built-in cable assembly for the **HON-AOR-CGW-ANT External Antenna**.

Label on Cable	Function Description
CELL	There are two (2) cables labeled as CELL . Connect either one to the CELL 1 or CELL 2 port on the HON-AOR-CGW-4G Cellular Gateway —any of the CELL cables can be connected to these ports.
GPS	Connect to the GPS port on the HON-AOR-CGW-4G Cellular Gateway .

Hardware Installation

 CAUTION	<p>It is the installer's obligation to ensure compliance with all national, regional, and local regulations. Installation should be performed only by qualified personnel in accordance with the National Electrical Code (NEC), NFPA 72, and other federal, state, and local statutes and building codes. Using shielded cable is recommended to avoid noise, hum, and other operational anomalies.</p>
--	---

1. Select a physical location in the building has strong cellular signal for either AT&T or Verizon networks.
2. Using the included U-bolt and pole-mount bracket, situate and secure the bracket in its preferred install location.
3. Temporarily remove the locknut from the external antenna assembly.
4. Clean and prepare the top surface of the pole-mount bracket with the included alcohol pad.
5. Remove the adhesive liner from the bottom of the external antenna and route the cable assembly into one of the through-holes on the pole-mount bracket. Place the antenna squarely onto the pole-mount bracket and press down so the adhesive secures it in place.
6. Using the locknut from **Step (3)**, fasten and secure the external antenna onto the pole-mount bracket.

 CAUTION	<p>CHECK AND ENSURE THAT THE HON-AOR-CGW-4G CELLULAR GATEWAY HAS NOT BEEN ENERGIZED OR POWERED ON.</p>
--	---

7. Route the external antenna cables into the enclosure of the HON-AOR-CGW-4G Cellular Gateway.

- Remove the internal modem from the internal mounting plate by unfastening the two (2) 8-32 x 5/16 hex nuts located in the two outlined areas as shown below.

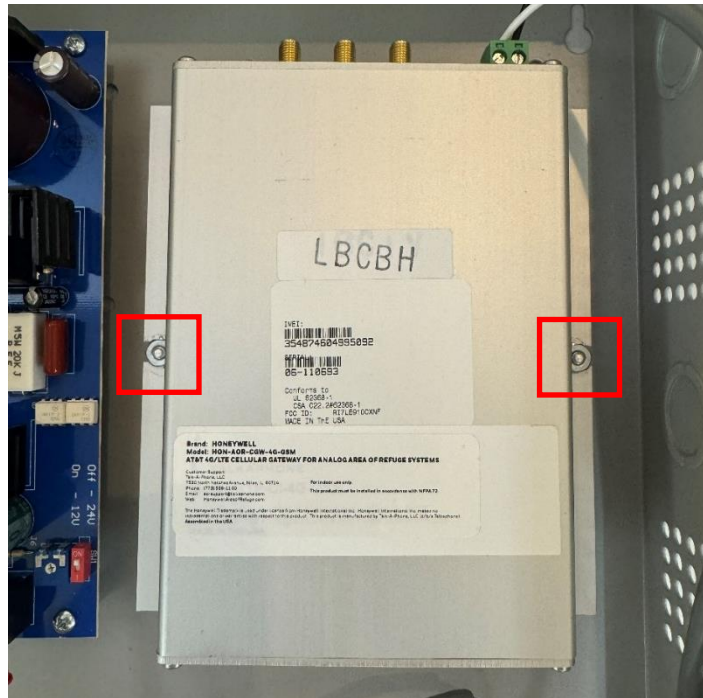

- Connect the cables from the external antenna assembly to the **CELL 1**, **CELL 2**, and, **GPS** connectors on the internal modem.

On the built-in cable assembly of the external antenna, there are two (2) cables labeled **CELL** – any of the two **CELL** cables can connect to either **CELL 1** or **CELL 2** connector.

 CAUTION	<p>DE-ENERGIZE POWER SUPPLY PRIOR TO SERVICING.</p> <p>For continued protection against risk of electric shock and fire hazard replace fuse with the same type and rating. Do not expose to rain or moisture.</p>
---	---

Servicing

For product service and repair, please contact:

Talkaphone Area of Refuge (AOR) Support

Email: aorsupport@talkaphone.com

Phone: 773.539.1100

Limited Warranty Information

For the latest warranty information, please visit:

<https://www.honeywellareaofrefuge.com/warranty>

Talk-A-Phone, LLC

7530 N. Natchez Ave.

Niles, IL 60714

773.539.1100

aorsupport@talkaphone.com

www.honeywellareaofrefuge.com

© 2024 Talk-A-Phone, LLC. All rights reserved. Specifications subject to change without notice.

The Honeywell trademark is used under license from Honeywell International Inc.
Honeywell International Inc. makes no representation or warranties with respect to these products.
These products are manufactured by Talk-A-Phone, LLC, Niles, IL 60714, USA.

771-00013 | Rev 1.0 | 07/15/2024

Honeywell